

User Manual

**DB 20 set**  
Demo Boards

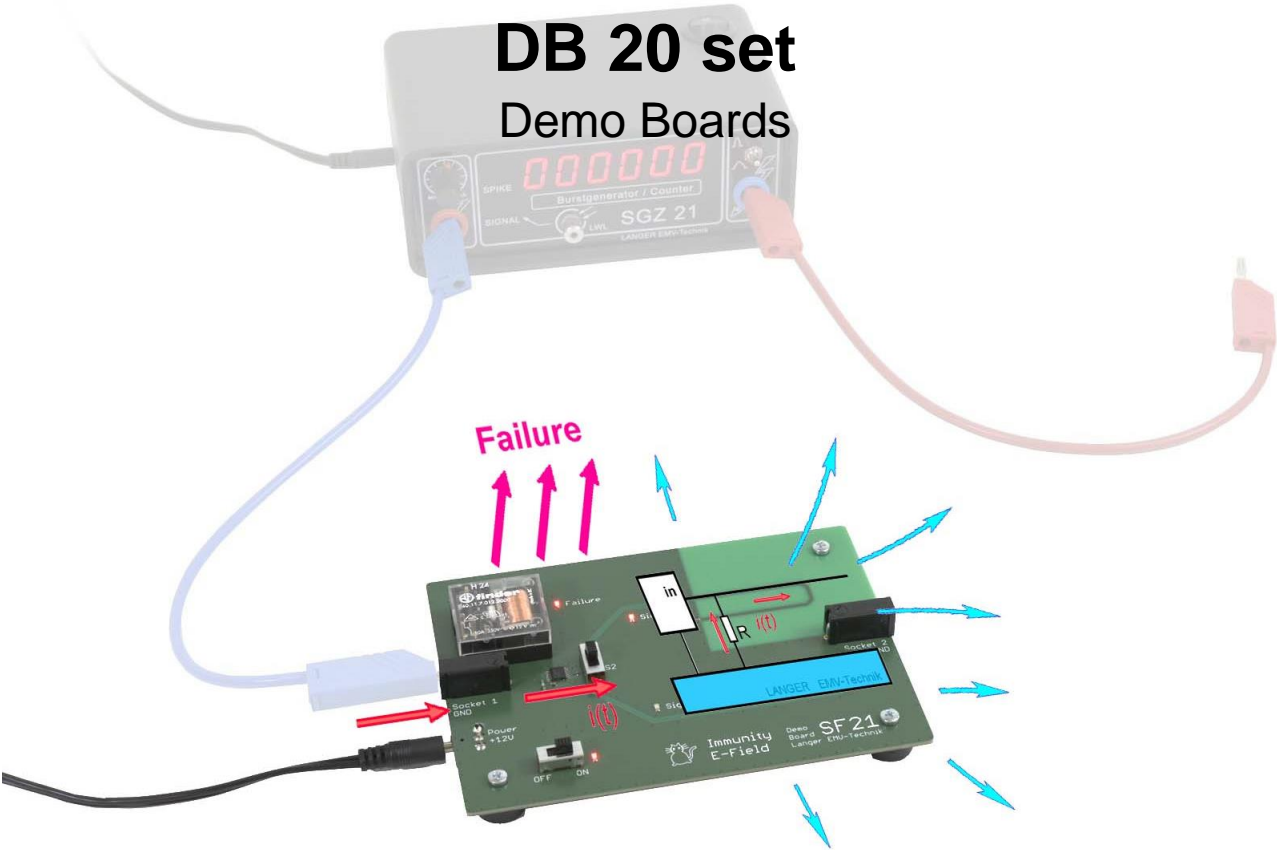

Demonstration of EMC measurement technology  
Demonstrate coupling mechanisms  
Detect layout influences

<b>Content</b>	<b>Page</b>
<b>1 Declaration of Conformity .....</b>	<b>3</b>
<b>2 General Information .....</b>	<b>4</b>
2.1 Storing the User Manual .....	4
2.2 Reading and Understanding the Manual .....	4
2.3 Local Safety and Accident Prevention Regulations .....	4
2.4 Images .....	4
2.5 Limitations of Liability .....	4
2.6 Errors and Omissions .....	4
2.7 Copyright .....	4
<b>3 Scope of Delivery .....</b>	<b>5</b>
<b>4 Technical Parameters .....</b>	<b>6</b>
<b>5 Safety Instructions .....</b>	<b>7</b>
<b>6 Structure and Function .....</b>	<b>8</b>
6.1 General Structure .....	8
6.2 Demo Boards for Demonstration of Interference Immunity .....	8
6.3 Demo Boards for Demonstration of Emission .....	11
<b>7 Demonstration Tests .....</b>	<b>15</b>
7.1 Demonstration Tests for Immunity .....	15
7.1.1 General Information .....	15
7.1.2 Tests with Burst Generator according to IEC 61 000-4-4 .....	15
7.1.2.1 SF 21: Tests for Electric Coupling .....	15
7.1.2.2 SF 11: Tests for Magnetic Coupling .....	17
7.1.3 Tests with PT4 Burst Transformer .....	18
7.1.4 Tests with SGZ 21 Burst Generator .....	19
7.1.4.1 Tests for Electric Coupling .....	19
7.1.4.2 Tests for Magnetic Coupling .....	20
7.1.5 Tests with Field Sources (H3 Set, Mini Burst Field Generators) .....	20
7.1.5.1 General Information .....	20
7.1.5.2 Tests for Electric Coupling .....	20
7.1.5.3 Test for Magnetic Coupling .....	20
7.1.6 Tests with ESD Generator .....	21
7.2 Demonstration Tests for Emission .....	22
7.2.1 Tests with an Antenna .....	22
7.2.2 Tests with ESA1 Emission Development System .....	23
7.2.3 Tests with Near-Field Probes .....	24
<b>8 Customer Support .....</b>	<b>28</b>
<b>9 Warranty .....</b>	<b>28</b>

# 1 Declaration of Conformity



Manufacturer:

Langer EMV-Technik GmbH  
Nöthnitzer Hang 31  
01728 Bannewitz  
Germany

Langer EMV-Technik GmbH hereby affirms, that the product specified below

**DB 20 set**, Demo Boards  
with SA 11, SA 21, SF 11, SF 21

agrees with the regulations of EC guidelines:

- Low Voltage Directive 2014/35/EU
- EMC Directive 2014/30/EU
- Restriction of certain Hazardous Substances 2011/65/EU

Applied standards and technical specifications:

- DIN EN 61000-6-3:2011-09 EMC - Emission
- DIN EN 61000-6-1:2007-10 EMC - Immunity
- DIN EN 50581:2013-02 (Restrictions of hazardous substances)

Person authorized to compile the technical file:

Gunter Langer

Bannewitz, 2020-04-02

A handwritten signature in blue ink, appearing to read 'G. Langer', is written in a cursive style.

(Signature)

G. Langer, Geschäftsführer

## **2 General Information**

### **2.1 Storing the User Manual**

This user manual provides the basis for the safe and efficient use of the DB 20 set. It must be kept handy and easily accessible for the user.

### **2.2 Reading and Understanding the Manual**

Read and understand the manual and observe the instructions carefully before using the DB 20 set. Please consult Langer EMV-Technik GmbH if you have any questions or comments.

The user manual must be kept readily available in the immediate vicinity of the product.

### **2.3 Local Safety and Accident Prevention Regulations**

The applicable local general safety and accident prevention regulations must be adhered to.

### **2.4 Images**

Images in this manual facilitate a better understanding, but can deviate from the actual execution.

### **2.5 Limitations of Liability**

The Langer EMV-Technik GmbH is not liable for personal injury or damage to material, if

- the instructions in this user manual were not followed.
- the product was used by personnel who are not qualified in the field of EMC and who are not fit to work under the influence of disturbance voltages and electric and magnetic fields.
- the product was not used as intended.
- the product was arbitrarily modified or technically altered.
- spare parts or accessories were used, that were not authorized by Langer EMV-Technik GmbH.

The actual scope of delivery can deviate from the texts and images in this manual in the case of individual adjustments to the order or recent technical changes.

### **2.6 Errors and Omissions**

The information in this user manual has been checked very carefully and found to be correct to the best of our knowledge; however, Langer EMV-Technik GmbH can assume no responsibility for spelling, typographical or proofreading errors.

### **2.7 Copyright**

The content of this user manual is protected by copyright and may only be used in connection with the DB 20 set. This user manual may not be used for other purposes without the prior consent of Langer EMV-Technik GmbH.

### 3 Scope of Delivery

<b>Item</b>	<b>Designation</b>	<b>Type</b>	<b>Qty.</b>
01	Demo Board Emission B-Field	SA 11	1
02	Demo Board Emission E-Field	SA 21	1
03	Demo Board Immunity B-field	SF 11	1
04	Demo Board Immunity E-Field	SF 21	1
05	Power Supply Unit	NT FRI EU	1
06	Lab Cable	LK 25 cm rt	1
07	Lab Cable	LK 25 cm bl	1
08	Copper adhesive tape	Tape Cu	3
09	User Manual	DB 20 m	1

**Important:** The scope of delivery may differ depending on the respective order.

## 4 Technical Parameters

Sizes of demo boards (with connectors) (L x B x H)	(140 x 100 x 23) mm
Supply voltage	12 V
Current input	ca. 20 mA
SA 11 demo board	Coupling of magnetic field
SA 21 demo board	Coupling of E-field
SF 11 demo board	Susceptible to magnetic field
SF 21 demo board	Susceptible to E-field
Table 1: DB 20 set technical parameters	

## **5 Safety Instructions**

If you use a Langer EMV-Technik GmbH product, please observe the following safety instructions to protect yourself against electric shock or the risk of injury.

The use of the device must be carried out by personnel who are competent in the field of EMC and suitable for this work under the influence of interference voltages and burst fields (electrical and magnetic).

- The operating and safety instructions of all devices used must be observed.
- Damaged or defective devices must not be used.
- Before operating a measuring station with a product of Langer EMV-Technik GmbH, carry out a visual inspection. Damaged connecting cables must be replaced before operation.
- The product of Langer EMV-Technik GmbH may only be used for applications for which it is intended. Any other use is not permitted.

## 6 Structure and Function

### 6.1 General Structure

With a total of four different demo boards, immunity and emission mechanisms can be displayed. The demo boards are printed circuit boards with the same basic structure (Figure 1):

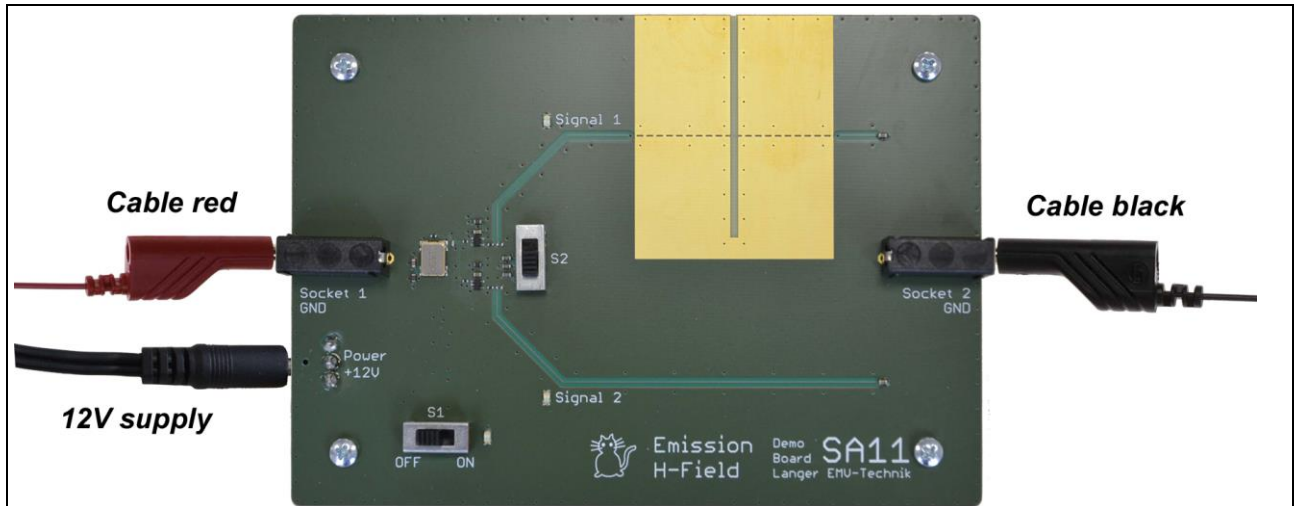

Figure 1: Demo board with connected cables

- Power is supplied by the included power supply unit and the socket labeled "Power +12 V" on the left side of the demo boards.
- The demo boards are switched on with the switch labeled "S1". For control purposes a red LED lights up directly to the right of the switch.
- All demo boards have two signal lines labeled "Signal 1" and "Signal 2" on the upper side, which can be switched by the switch labeled "S2". The currently active signal line is indicated by a red LED directly at the lettering "Signal 1" or "Signal 2". On all demo boards, the signal line Signal 1 is installed without EMC protection. In contrast, the signal line Signal 2 is embedded in GND. All demo boards have four layers.
- On the left and right side of the demo boards there is a 4 mm socket labeled "Socket 1 GND" and "Socket 2 GND" respectively. Depending on the test set-up, the supplied laboratory cables or possibly existing laboratory cables of other lengths can be connected there.
- Four rubber feet allow the Demo Boards to stand safely on both insulating and conductive surfaces.

### 6.2 Demo Boards for Demonstration of Interference Immunity

The SF demo boards (Fig. 2) are suitable for demonstrating the influence of electronic circuits in the presence of interference pulses from the environment such as burst and ESD. They can be used in conjunction with burst generators according to IEC 61000-4-4, ESD generators according to IEC 61000-4-2, E1 set development system immunity and field sources from Langer EMV-Technik GmbH.

Interference is either caused by magnetic fields (SF 11 demo board) or by electric fields (SF 21 demo board).



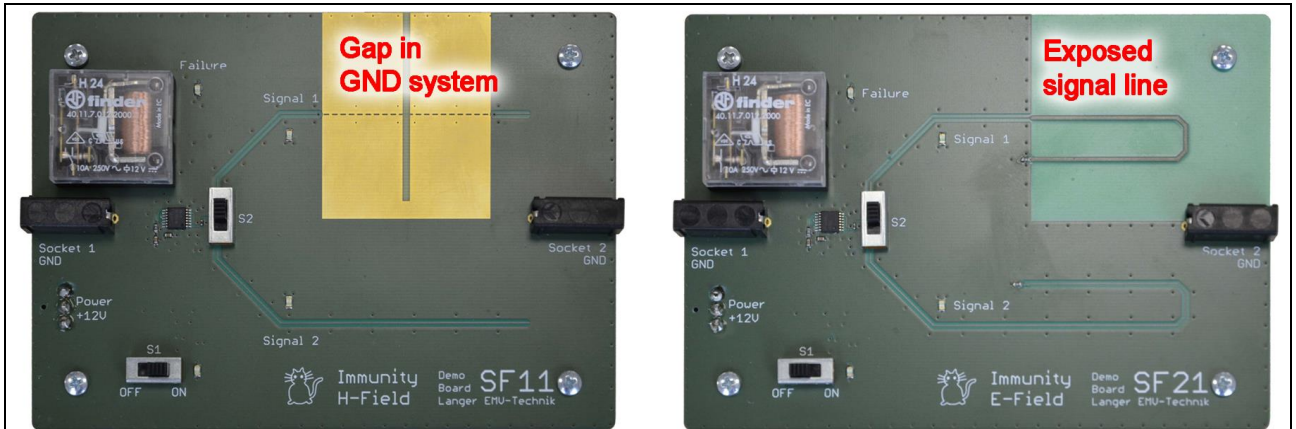

Figure 2: Demo boards for immunity SF 11 (magnetic fields) and SF 21 (electric fields)

**Function:**

The switch S2 connects either the signal line Signal 1 or the signal line Signal 2 to an IC input. If the signal in question is affected by a disturbance pulse, the IC outputs a signal lasting approx. 100 ms to the LED labelled "Failure" and to the relay. The influence is thus clearly visible and can be clearly heard through the relay clacking.

As in the uninfluenced condition the signals are always connected to GND - i.e. are detected by the IC as "low" or "0", an influence only occurs with positive interference pulses. The measurement results are therefore always dependent on the polarity set on the interference generators.

**Interference of SF 11 Demo Board:**

Signal 1 of the SF 11 is sensitive to a pulsed magnetic field or to current pulses flowing through the SF 11:

A current flowing through the SF 11 generates a magnetic field that orbits the GND plane. Part of the field lines runs through the gap in the GND plane and thus induces an interference voltage in the loop of Signal 1 and GND (highlighted in red in Figure 3). The LED labeled "Failure" lights up, the relay switches.

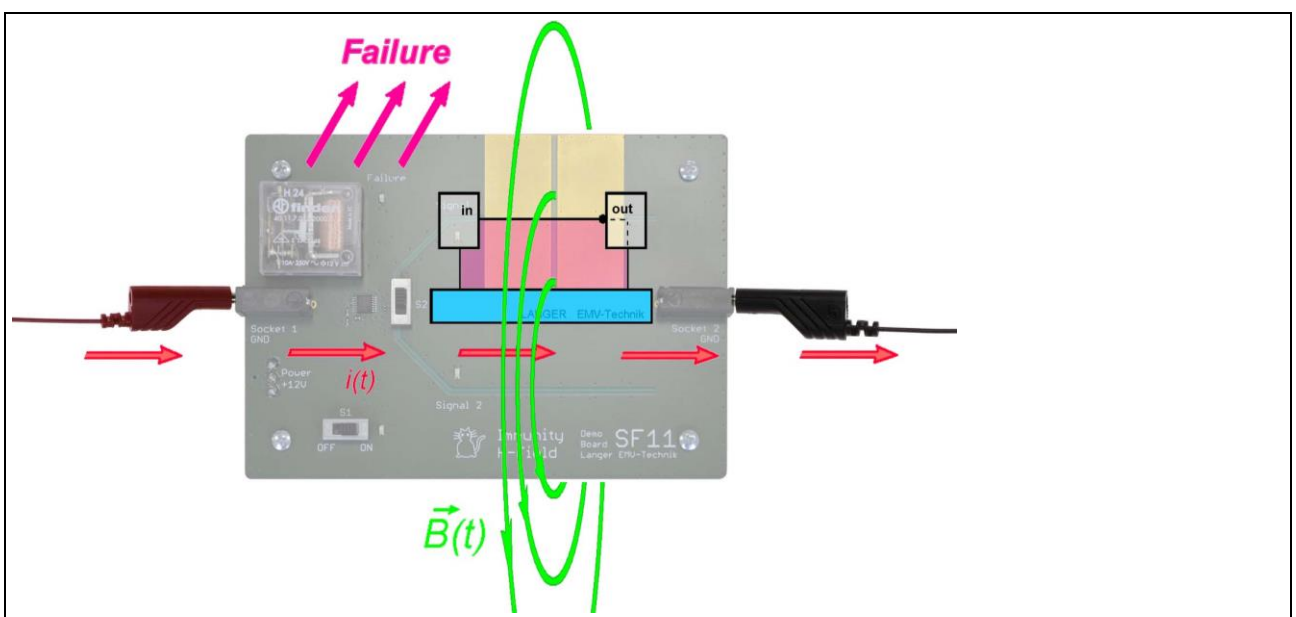

Figure 3: Interference of the SF 11 by pulse current

The Signal 2 is routed close to the GND plane throughout its entire course (Figure 4). There is almost no magnetic field between signal and GND plane. The SF 11 is largely immune to interference.

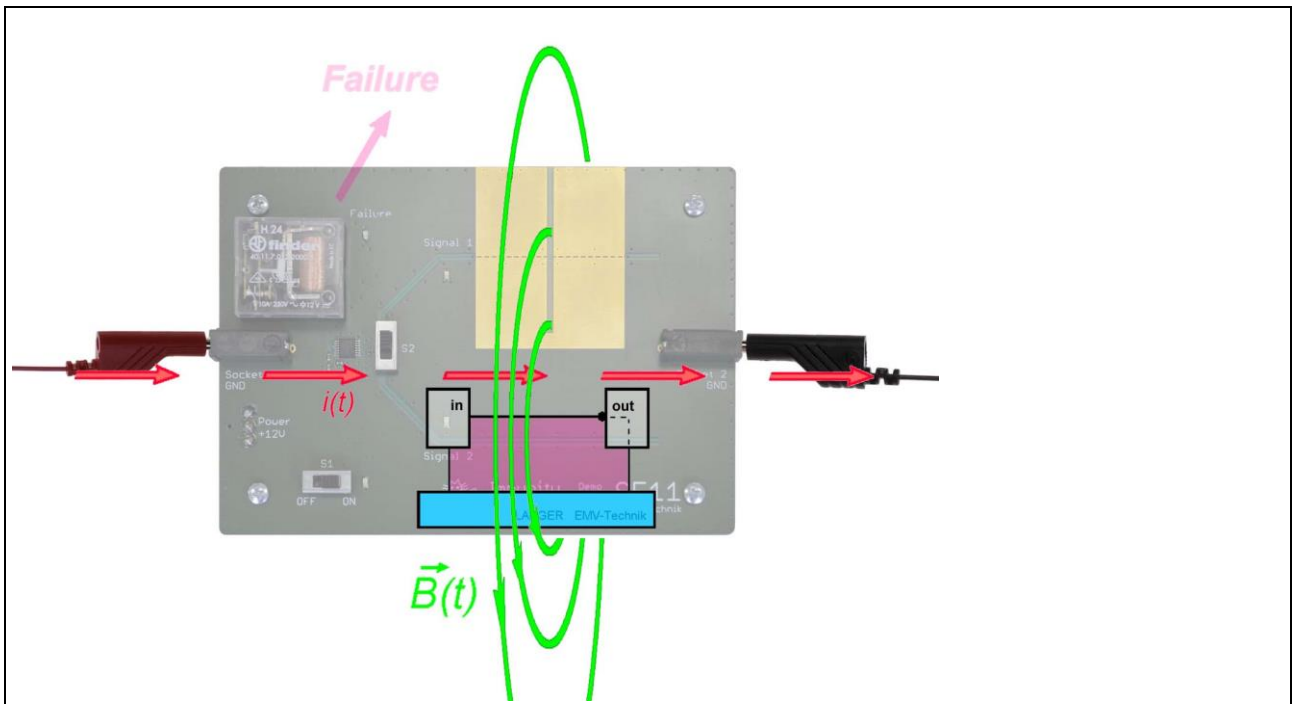

Figure 4: Signal 2 of the SF 11 is not affected

#### Interference of SF 21 Demo Board:

Signal 1 of the SF 21 is sensitive to a pulsed electric field.

An interference current flowing into the SF 21 through Socket 1 must be capacitively decoupled if no cable is connected to Socket 2 (Figure 5). This capacitive current (displacement current) mainly flows from GND to the environment. However, a smaller partial current flows from GND through resistor R into the exposed line Signal 1 and from there to the surroundings. A voltage drop occurs at R, which leads to interference.

Common practical examples of this are RESET lines, chip select lines or programming inputs.

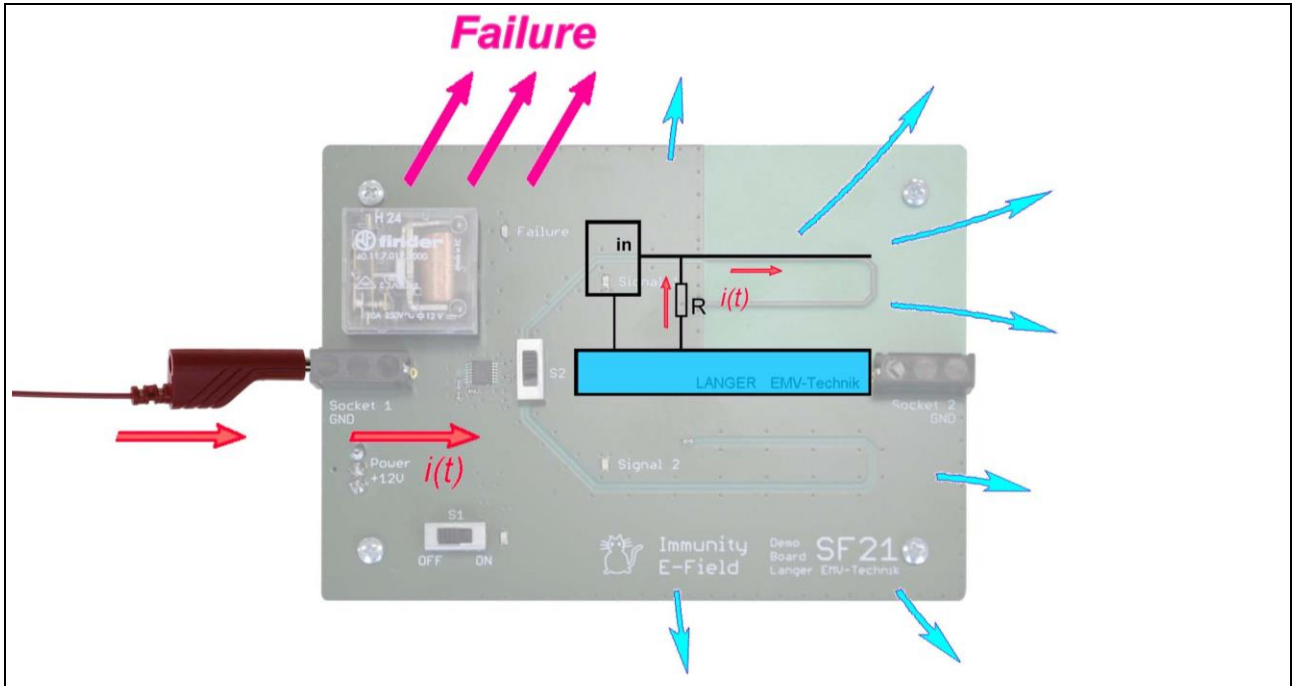

Figure 5: Interference of the SF 21 by E-field

The influence of Signal 2 is considerably less, because the signal line runs very close to the GND plane throughout the whole path. The current capacitively decoupling from the signal line is therefore very small.

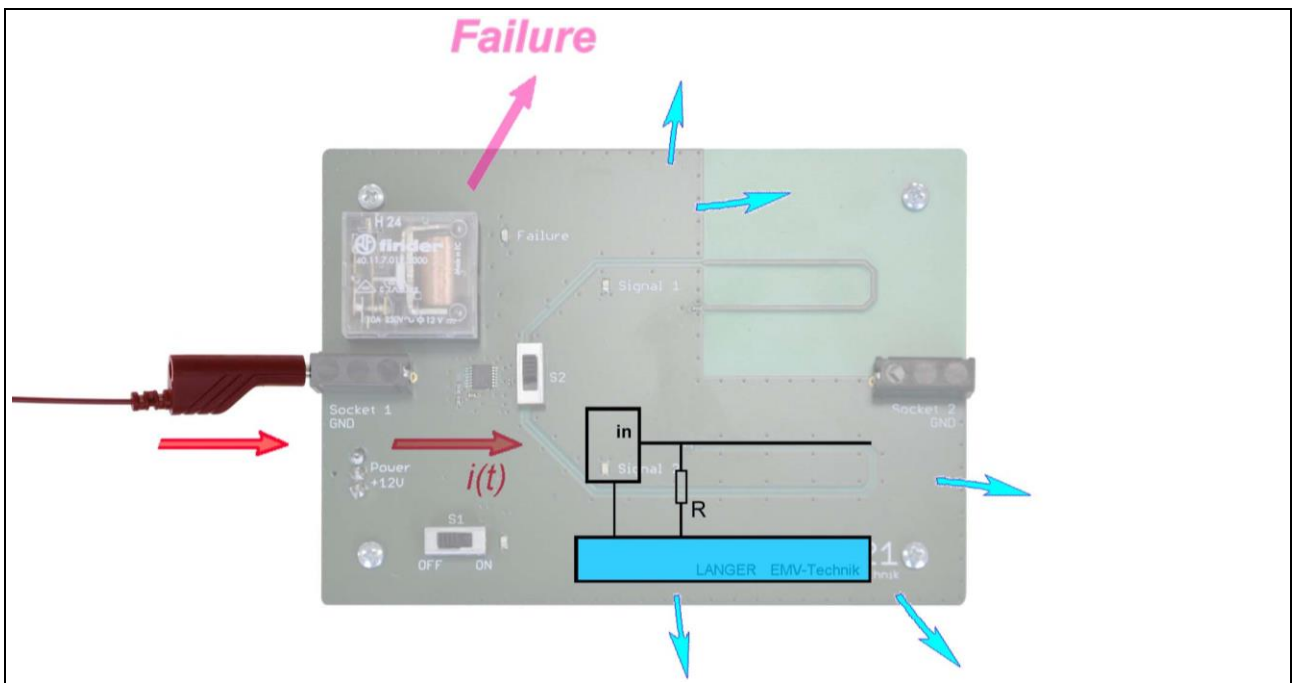

Figure 6: Signal 2 of the SF 21 is not affected

### 6.3 Demo Boards for Demonstration of Emission

Together with a spectrum analyzer, the SA demo boards (Figure 7) are suitable for demonstration experiments on interference emission. They can be used in conjunction with antennas, near-field probes and the ESA1 development system of the Langer EMV-Technik GmbH.

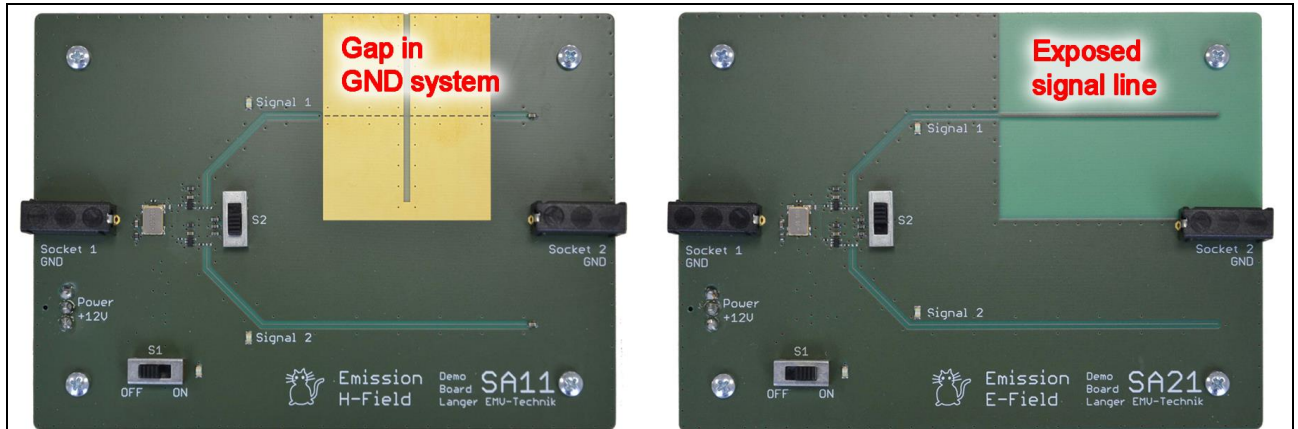

Figure 7: Demo boards for interference emission SA 11 and SA 21

### Emission of SA 11 Demo Board:

The oscillator of the SA 11 generates a digital signal at 10 MHz, which is fed from the output of an IC via the line Signal 1 or Signal 2 to a capacitor. This capacitor simulates the capacitive load that would be present in a real assembly by the input capacitance of a connected IC input or by the gate capacitance of a transistor. This results in a current which generates a magnetic field  $B$ . In Figure 8, Signal 1 is active. The conductor loop Signal 1 - Capacitor - GND runs across the gap in the GND system, the resulting magnetic field is shown in green. The component  $B_1(t)$  of the magnetic field orbits the GND system and induces a voltage  $U_{ind}$ , which leads to interference emission.

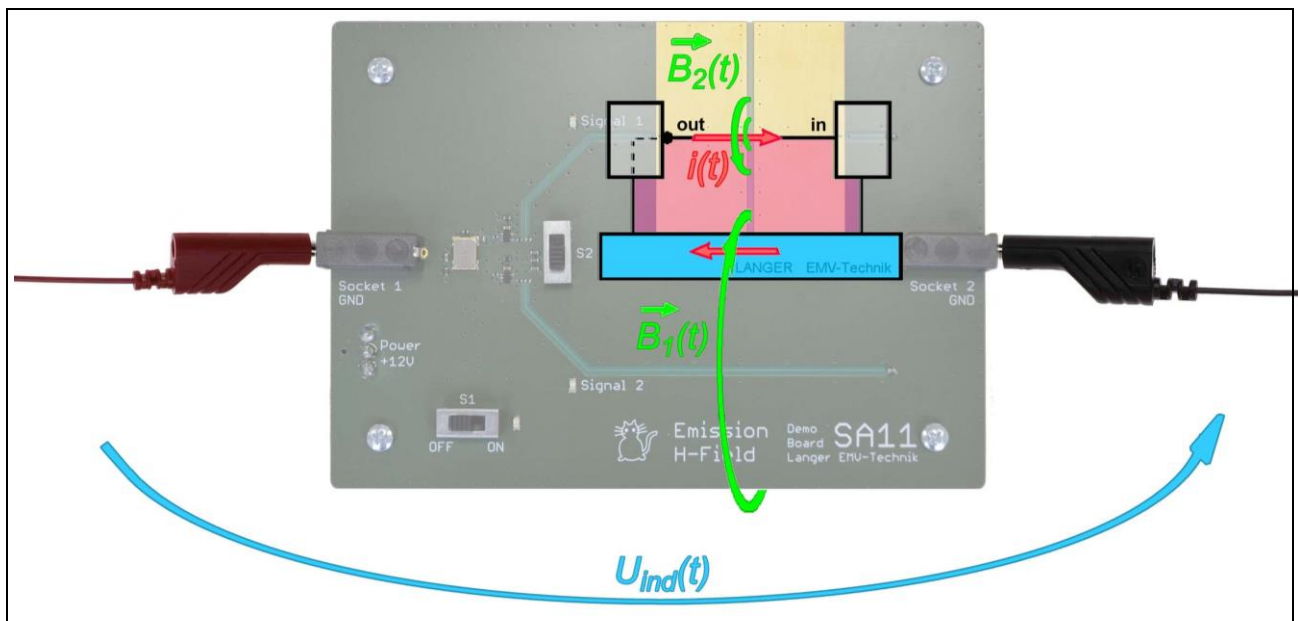

Figure 8: Emission by magnetic field at SA 11

If Signal 2 is used as the source, the emission is significantly lower, since the conductor loop Signal 2 - capacitor - GND is completely backed with GND and therefore cannot form the magnetic field.

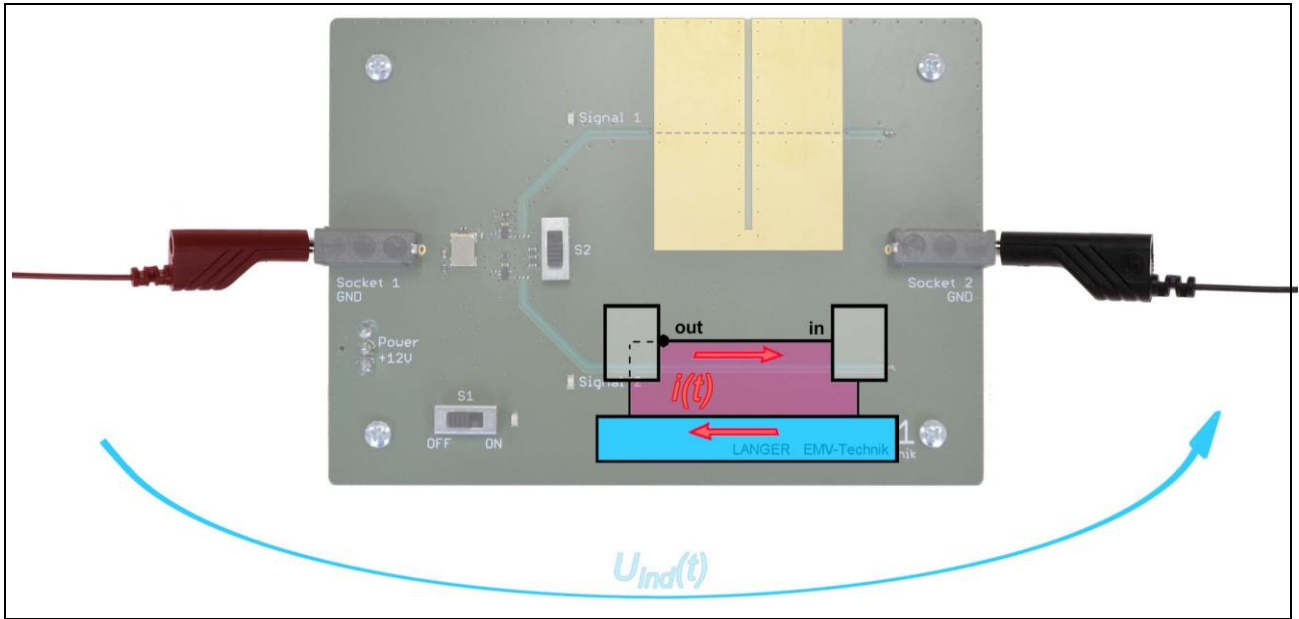

Figure 9: Signal 2 des SA11 erzeugt nahezu kein magnetisches Feld

#### Emission of SA 21 Demo Board:

Unlike the SA 11, no components are connected to Signal 1 and Signal 2 of the SA 21. The capacitive coupling to GND is limited to the parasitic capacitances caused by the layout. This results in a much larger electric field (Figure 10).

In real circuits this corresponds to signals that drive inputs with very small input capacitance or that are used for programming (pull-up resistors of several kOhm have almost no significance for HF).

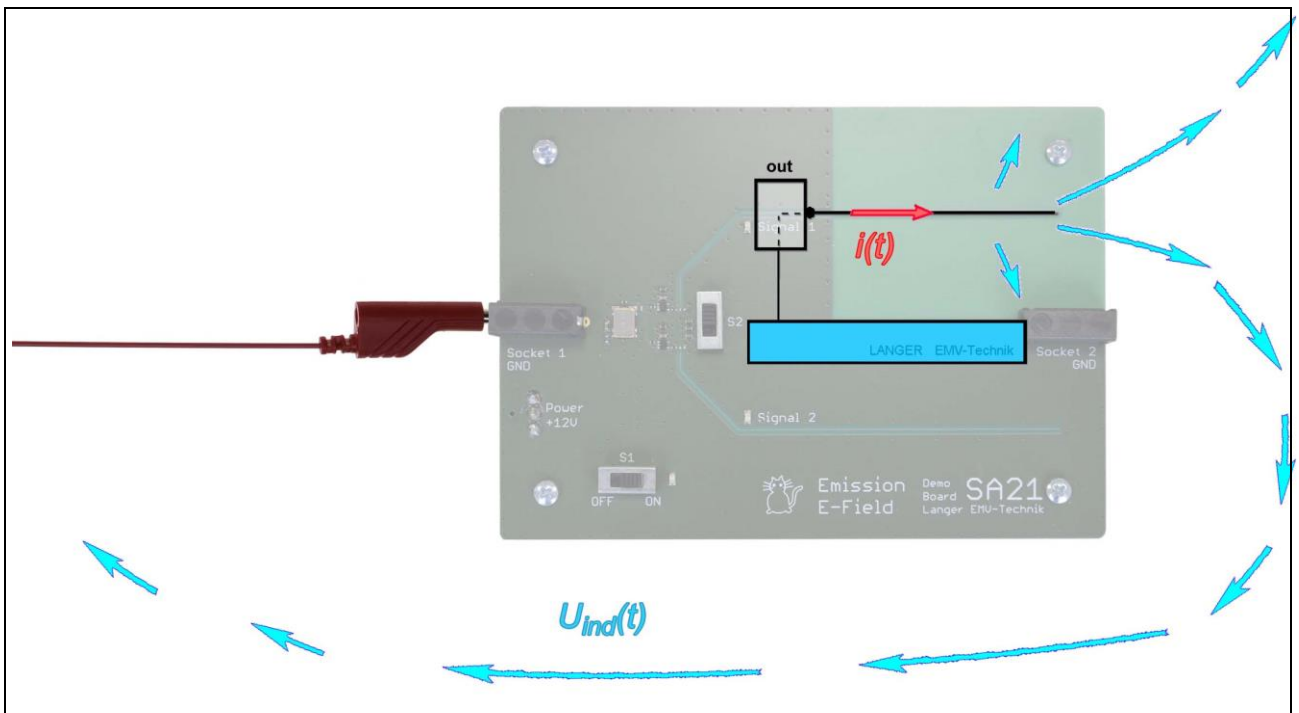

Figure 10: Signal 1 of SA 21 generates E-field



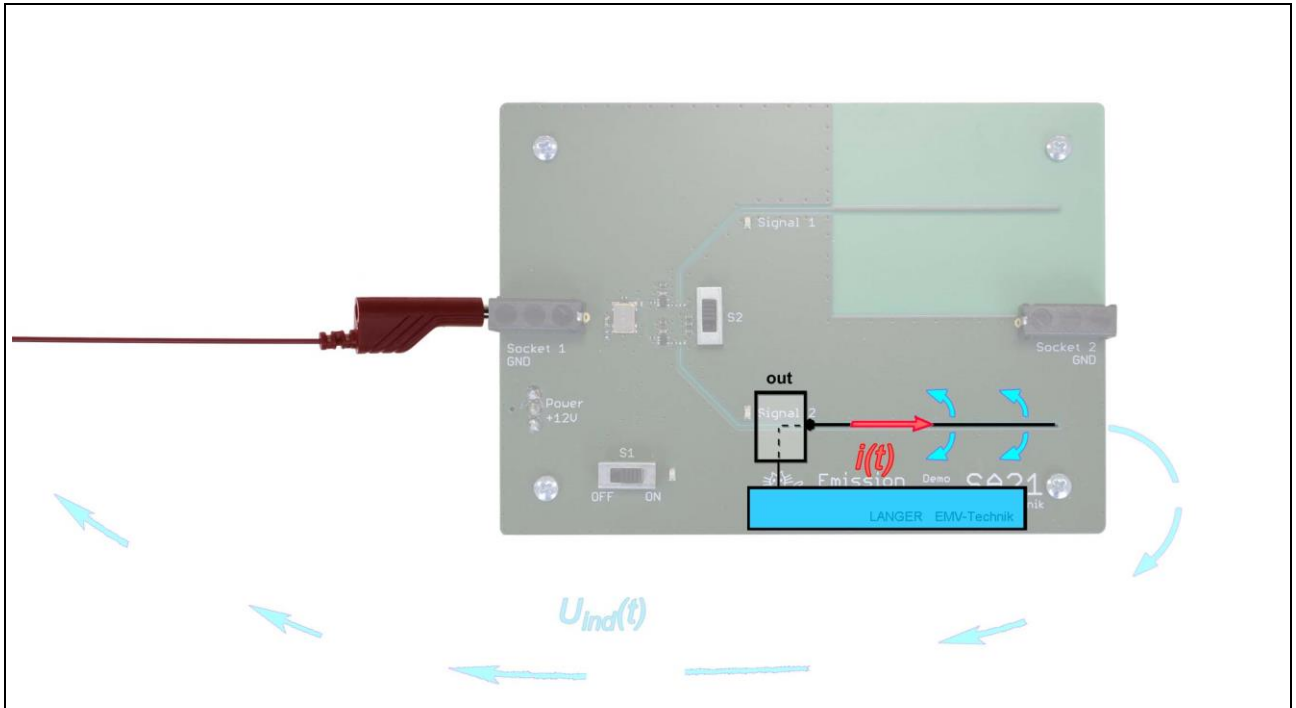

Figure 11: The E-field of Signal 2 couples back to GND

## 7 Demonstration Tests

### 7.1 Demonstration Tests for Immunity

#### 7.1.1 General Information

Immunity measurements are usually performed at a fixed distance above a metallic surface. This reduces environmental influences and makes measurements carried out at different locations comparable.

To simplify the measurement set-up during practical demonstrations, all measurements described below are carried out above a wooden table without metal base. However, the small and light measurement set-up is opposed by a larger measurement uncertainty. We recommend always making pre-measurements before presentations to determine the actual properties of the measurement set-up in the actual environment.

#### 7.1.2 Tests with Burst Generator according to IEC 61 000-4-4

##### 7.1.2.1 SF 21: Tests for Electric Coupling

Example: SF 21 demo board with one cable

- SF 21 is connected via power supply unit to the socket adapter network of the burst generator
- Burst current flows from the generator to the device under test
- Capacitive decoupling from the device under test (generation of E-field)
- Backflow through the air to the burst generator (parasitic capacity)

Interference from:

Signal 1:  
+0.7 kV  
- 0.6 kV

Signal 2:  
> +4.4 kV  
> - 4.4 kV

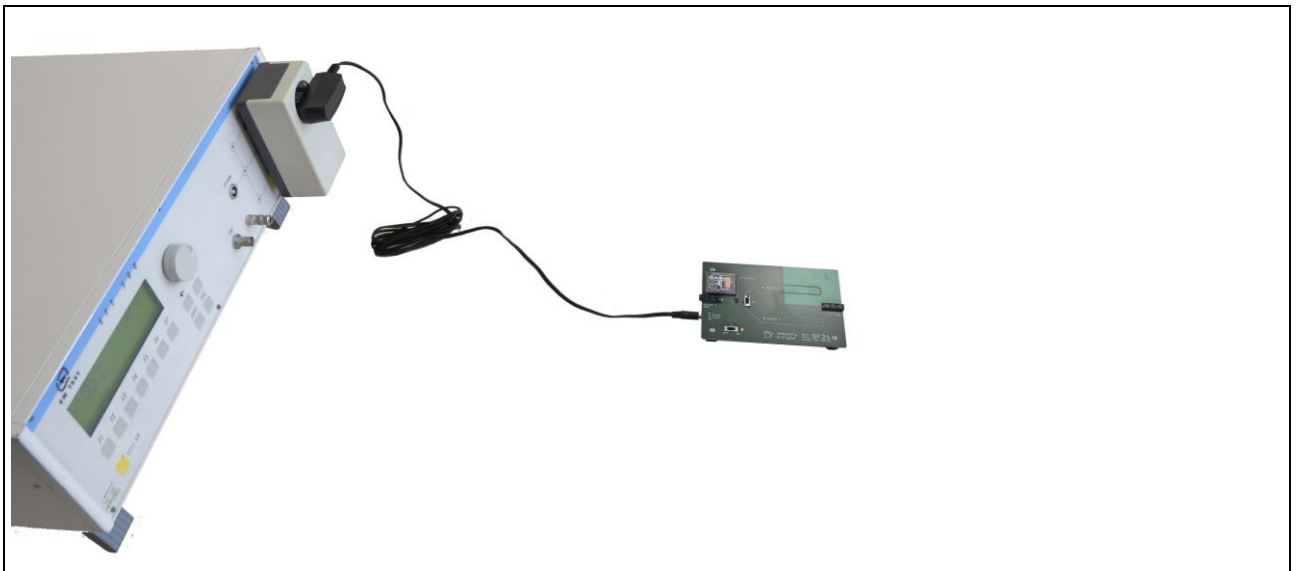

Figure 12: SF 21 connected to the burst generator with one cable

Example: SF 21 demo board with two connected cables:

- the interference immunity is increased because the second cable reduces the electric field strength in the area of the demo board

Interference from:	Signal 1:	Signal 2:
	+1.1 kV	> +4.4 kV
	- 1.0 kV	> - 4.4 kV

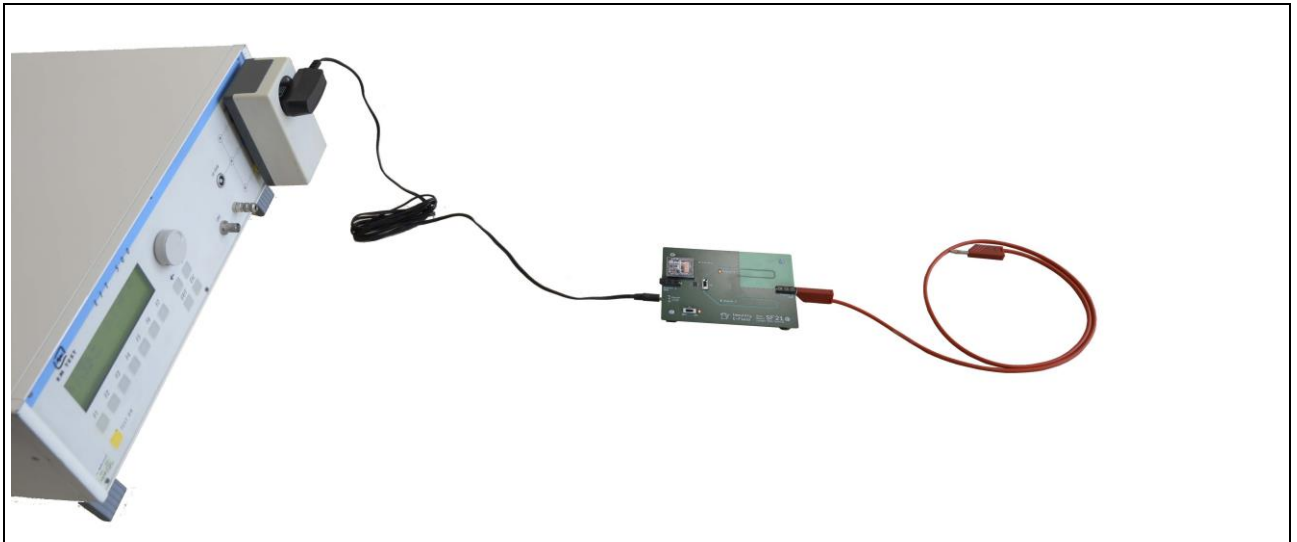

Figure 13: SF 21 operated on burst generator with two cables

Example: SF 21 demo board with two cables connected, the second cable is connected to GND of the burst generator

- the immunity is further increased because the voltage generated by the burst generator is short-circuited to GND - the electric field strength is low

Interference from:	Signal 1:	Signal 2:
	+2.1 kV	> +4.4 kV
	- 1.8 kV	> - 4.4 kV

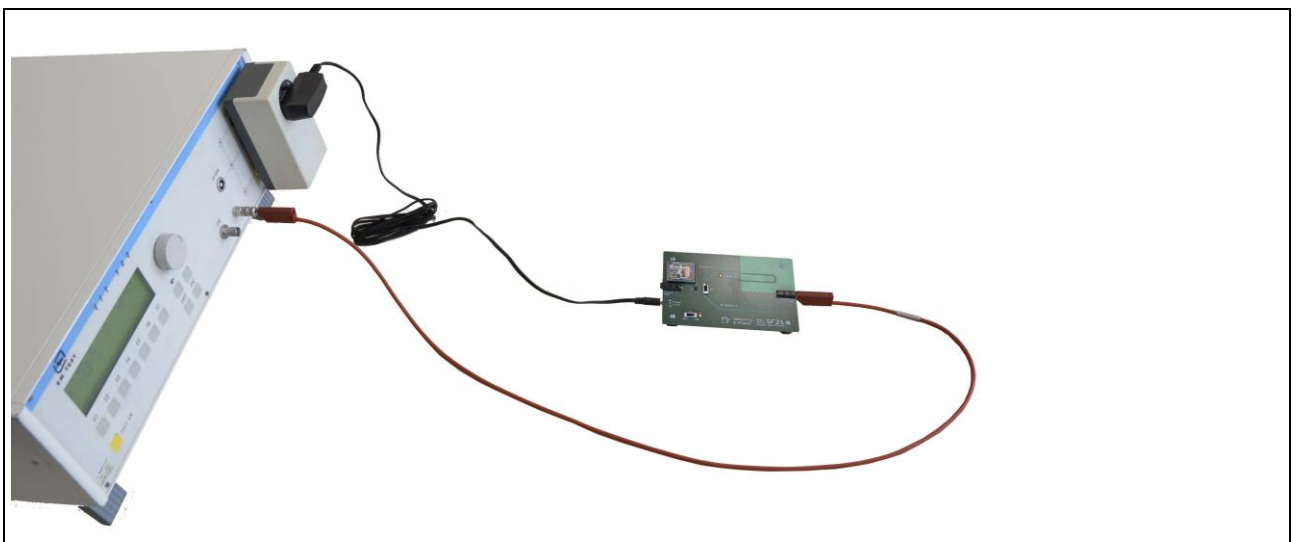

Figure 14: SF 21 operated on burst generator with two cables and low-impedance interference current path



### 7.1.2.2 SF 11: Tests for Magnetic Coupling

Example: SF 11 demo board with one cable

- SF 11 is connected via power supply unit to the socket adapter network of the burst generator
- low burst current from the generator to the device under test, since the current can only flow back to the generator through the (small) parasitic capacity
- thus only low current flow through the SF 11 and low magnetic coupling into the signal conductor loop

Interference from:	Signal 1:	Signal 2:
	> +4.4 kV	> +4.4 kV
	> - 4.4 kV	> - 4.4 kV

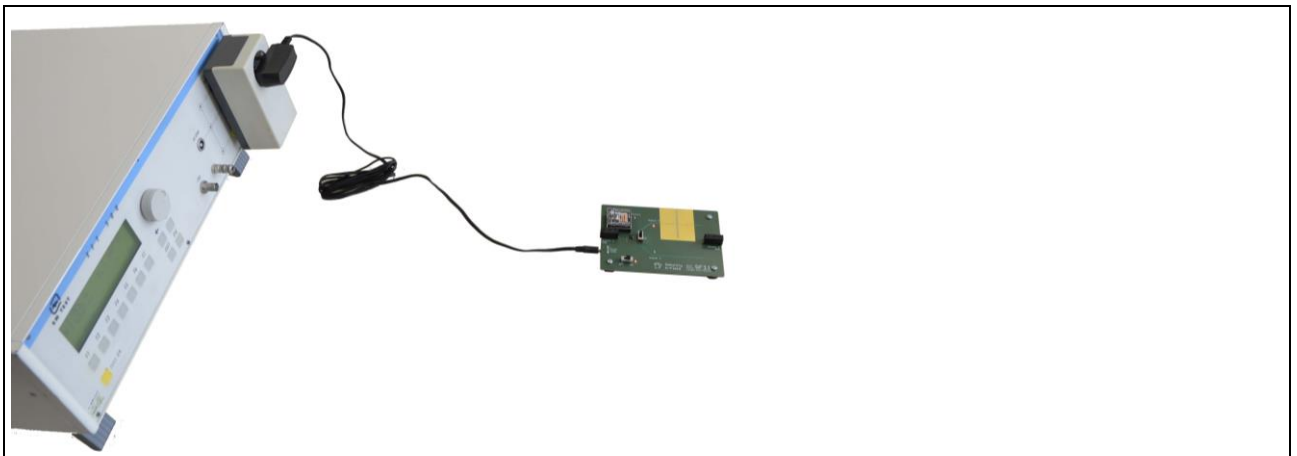

Figure 15: SF 11 connected to the burst generator with one cable

Example: SF 11 demo board with two connected cables

- the immunity is reduced, because the second cable increases the current and thus the magnetic field in the area of the demo board

Interference from:	Signal 1:	Signal 2:
	+2.1 kV	> +4.4 kV
	- 1.9 kV	> -4.4 kV

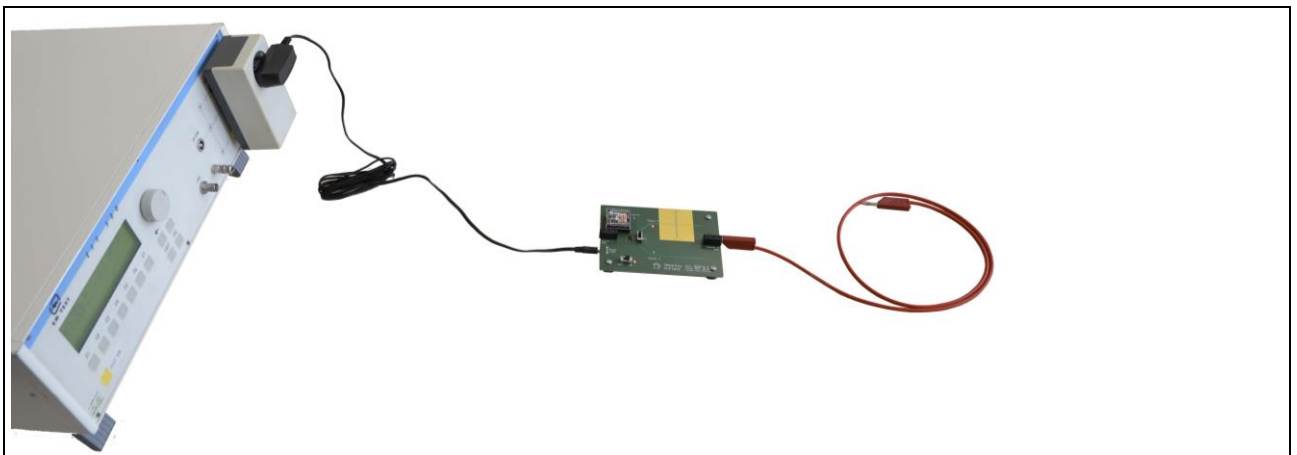

Figure 16: SF 11 operated on burst generator with two cables

Example: SF 11 demo board with two cables connected, the second cable is connected to GND of the burst generator

- the immunity to interference is further reduced, since the voltage generated by the burst generator is shorted to GND, thereby maximizing the current and the magnetic field

Interference from:	Signal 1:	Signal 2:
	+1.1 kV	> +4.4 kV
	- 1.3 kV	> - 4.4 kV

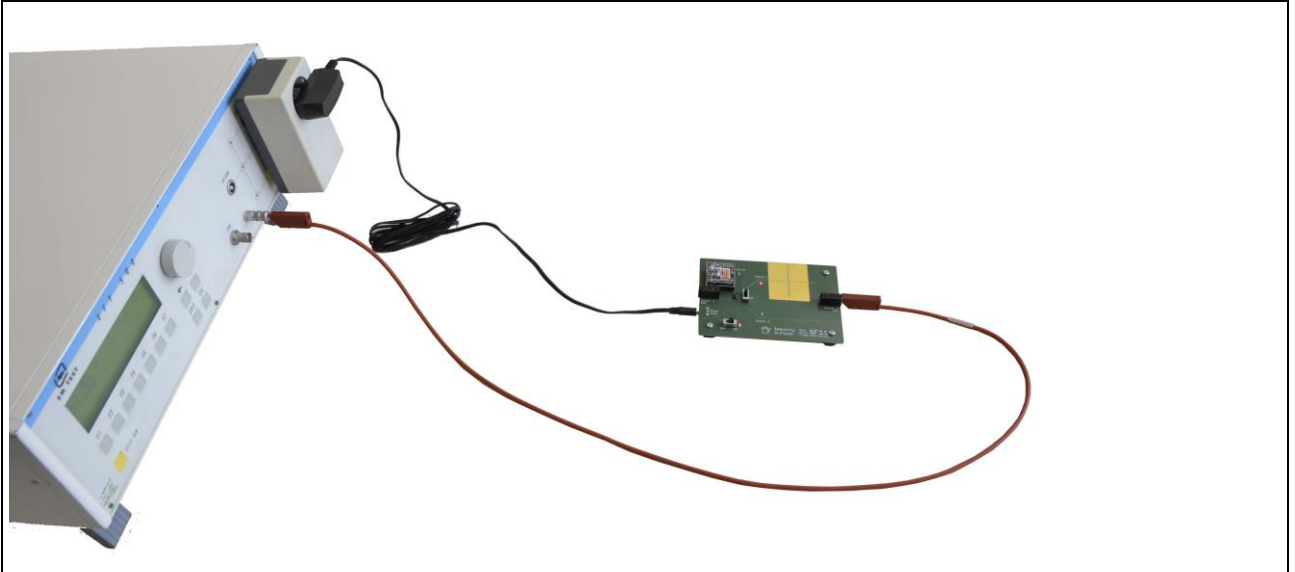

Figure 17: SF 11 operated on burst generator with two cables and low-impedance interference current path

### 7.1.3 Tests with PT4 Burst Transformer

For specific tests of DUTs with burst current or burst voltage the PT4 burst transformer can be used. It is connected to the output of a burst generator instead of a coupling clamp and converts the generator pulses referred to GND into potential-free pulses. This makes it possible to connect and disconnect burst current at almost any point on a DUT.

The single-pole connection to the DUT in Figure 18 on the left creates a large E-field at low current. In Figure 18 on the right, the E-field is very low at maximum current (magnetic field).

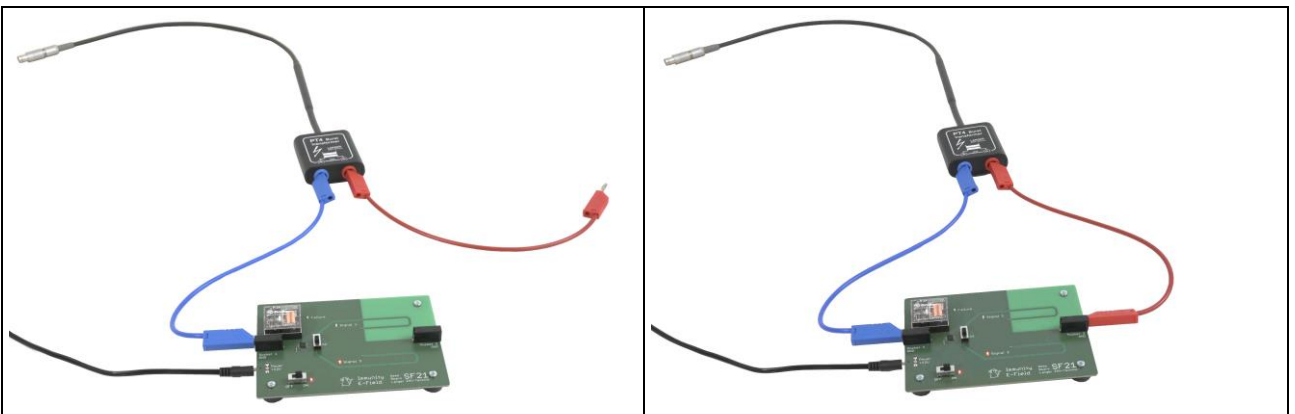

Figure 18: Single-pole and two-pole coupling with the PT4 burst transformer

## 7.1.4 Tests with SGZ 21 Burst Generator

### 7.1.4.1 Tests for Electric Coupling

Example: SF 21 demo board with one cable

- SF 21 is supplied via power supply unit. One output of the SGZ 21 is connected via Socket 1. At the second output of the SGZ 21 there is a cable which is not connected to the SF 21 (Figure 19).
- As there is no low-impedance connection between the two generator outputs, there is a large voltage difference and thus an electric field which couples into the line Signal 1 and causes an error.
- The line Signal 2 is protected within the GND area and is much less sensitive.

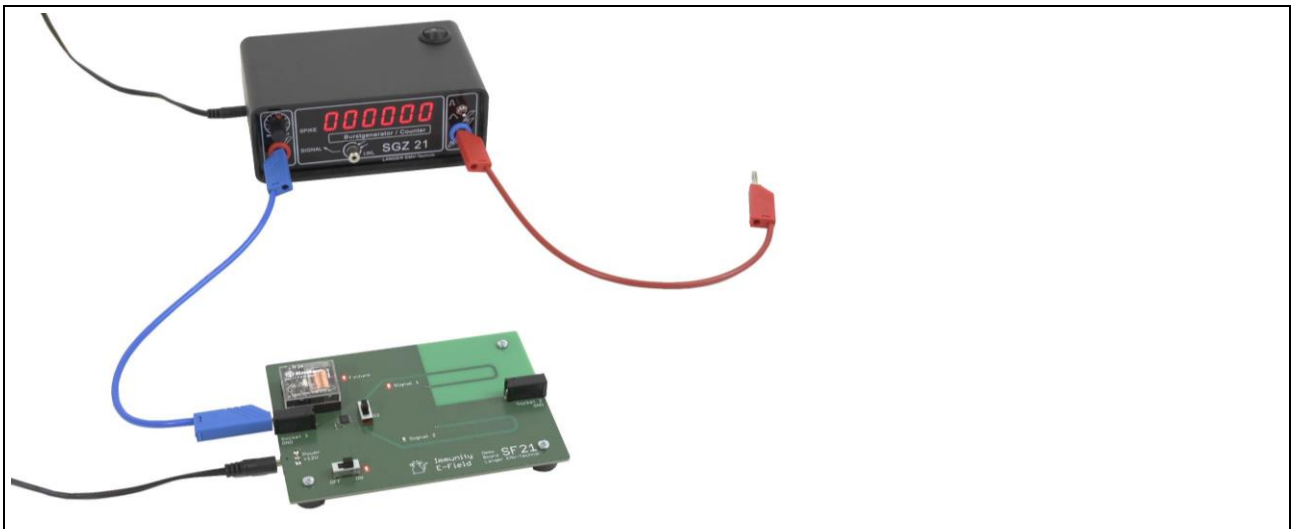

Figure 19: SF 21 is single-pole connected to the SGZ 21

If the SGZ 21 is connected to the SF 21 with two cables (Figure 20), a low-impedance current path is created. The interference current and thus the magnetic field increase, while the electric field decreases at the same time.

Since the SF 21 demo board reacts mainly to electric field, the immunity increases significantly when the second cable is connected.

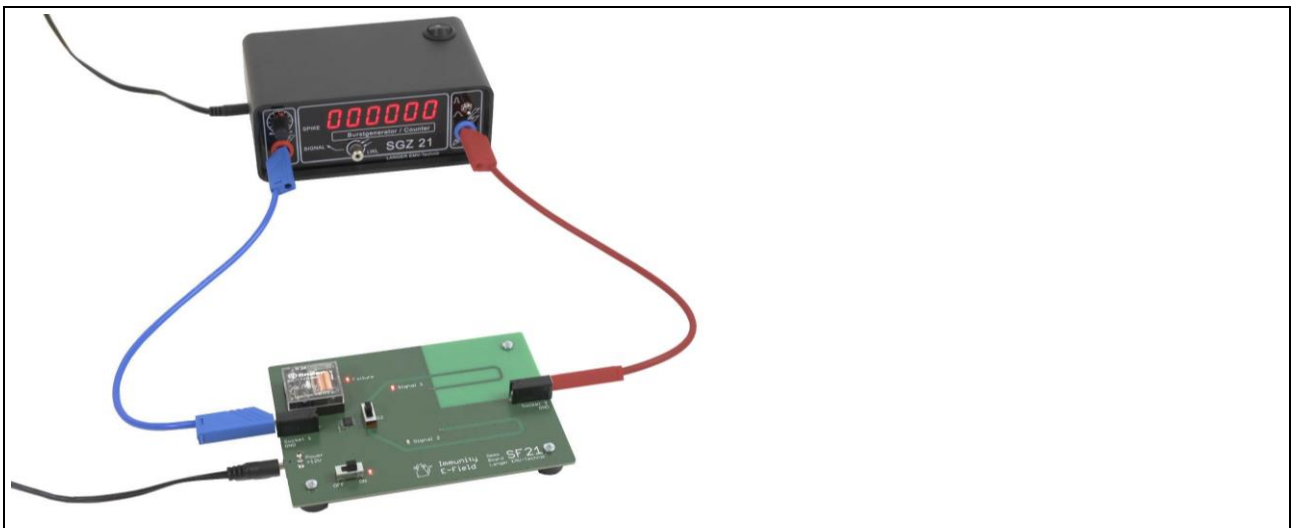

Figure 20: SF 21 is two-pole connected to the SGZ 21

### 7.1.4.2 Tests for Magnetic Coupling

The experiments presented in Section 7.1.4.1 for electrical coupling with the SF 21 demo board can also be carried out with the SF 11 demo board. Since the SF 11 reacts to magnetic fields, the test results are exactly the opposite:

- two-pole coupling generates a large interference current – immunity to interference is low,
- single-pole coupling generates a smaller interference current – immunity is higher.

### 7.1.5 Tests with Field Sources (H3 Set, Mini Burst Field Generators)

#### 7.1.5.1 General Information

With field sources for coupling magnetic or electric fields, printed circuit boards can be tested for their immunity to interference during development. It is important for the developer to recognize the relationship between the type of functional fault (LED flashing, RESET, defect) and the location and type of the coupled field (electric or magnetic field) in order to improve the DUT by effective modifications.

A statement about the absolute value of the immunity to interference with standardized measuring methods cannot be derived from measurements with probes.

#### 7.1.5.2 Tests for Electric Coupling

For the local coupling of electric fields, the P21 mini burst field generator (E), the ES 05 E-field probe from the E1 immunity development system and the ES 05 (h) from the H3 set for burst generators according to IEC 61 000-4-4 are suitable, for example.

With these or similar field sources, the DUT can be scanned by hand at a distance of a few millimeters. A high-impedance signal (SF 21 demo board, see Section 6.2) reacts much more sensitively than a low-impedance signal (SF 11 demo board).

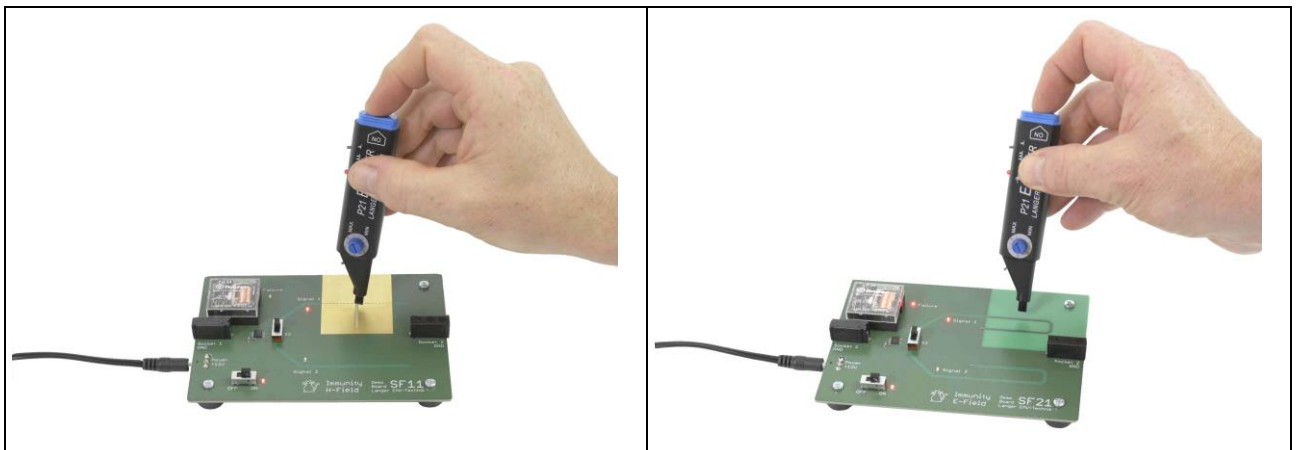

Figure 21: The SF 21 demo board is much more sensitive than the SF 11 in case of E-field coupling

#### 7.1.5.3 Test for Magnetic Coupling

Analogous to the E-field coupling, a local magnetic field can be coupled in (with P11 mini burst field generator, BS 04 or BS 04 (h) magnetic field source). The SF 11 demo board is particularly sensitive to magnetic fields in the area of the GND slot (Signal 1) (Figure 22).

It should be noted that the magnetic field must pass between GND and the signal line so that an interference voltage is induced in the loop between GND and signal line. The magnetic field strength directly on the signal line is of no importance.

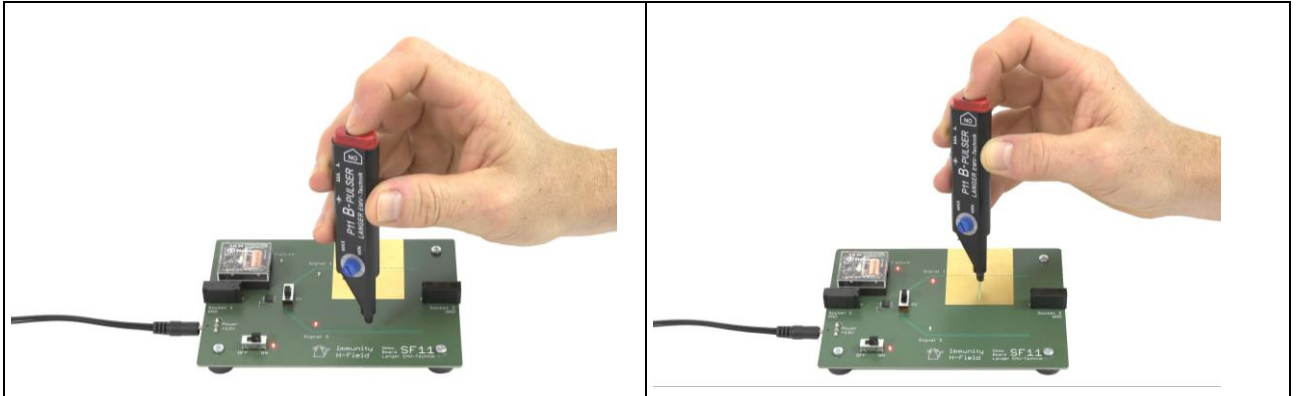
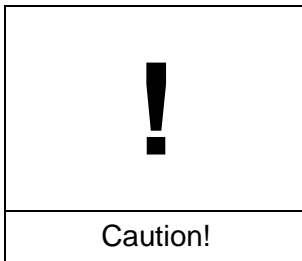

Figure 22: The SF 11 demo board reacts to magnetic fields in the area of the GND gap

### 7.1.6 Tests with ESD Generator



**Tests with ESD generators according to IEC 61 000-4-2 require special caution!**

**The demo boards can be destroyed if the test set-up is not carried out properly!**

For tests with ESD generators a metallic base plate (not included in the scope of delivery) is absolutely necessary. Both the ground connection of the ESD generator and the GND of the demo board must be connected to this base plate. The length and position of these connections influences the test result. In Figure 23 these connections are realized by a blue laboratory cable with connected terminal (demo board) and by a screw connection (ESD generator).

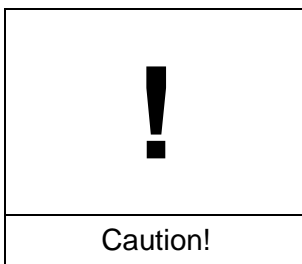

**The ESD generator must be operated in such a way that no direct discharge of the ESD generator into electronic components and their connecting cables can occur.**

Optimal is a contact discharge into the 4 mm Socket 2 as shown in Figure 23. This design ensures reproducible measurement results and protects the demo board (no flashovers into sensitive components and cables possible).



Figure 23: Experiments with ESD generator over a metal surface

While tests with active Signal 1 both demo boards (SF 11 and SF 21) are affected even at low ESD voltages, their immunity to interference is greater than 9 kV with active Signal 2.

Due to the very short rise time of the ESD pulse in the area of the demo boards, both electrical and magnetic fields are present.

Typical measurement results are:

SF 11: Interference from:	Signal 1:	Signal 2:
	+0.9 kV	> +9.0 kV
	- 4.0 kV	> - 9.0 kV
SF 21: Interference from:	Signal 1:	Signal 2:
	+0.8 kV	> +9.0 kV
	- 0.8 kV	> - 9.0 kV

It is not recommended to increase the generator voltage above 9 kV.

## 7.2 Demonstration Tests for Emission

### 7.2.1 Tests with an Antenna

Laboratory cables can be connected to one or both GND sockets of the SA 11 and SA 21 demo boards. Together with the demo boards, these cables act as an antenna and generate an interference emission which can be measured with a receiving antenna, e.g. in an anechoic chamber.

However, during demonstrations at events, unfavorable environmental conditions usually prevail. Laptops, beamers, audio systems and similar equipment generate a high level of interference, so that the emission of the demo boards can only be measured to a very limited extent. The curves shown in Figure 24 were generated under favorable environmental conditions and with the antenna placed close to the test set-up. If demonstrations with an antenna are planned, it is essential to make preliminary measurements and select suitable tests based on the results.



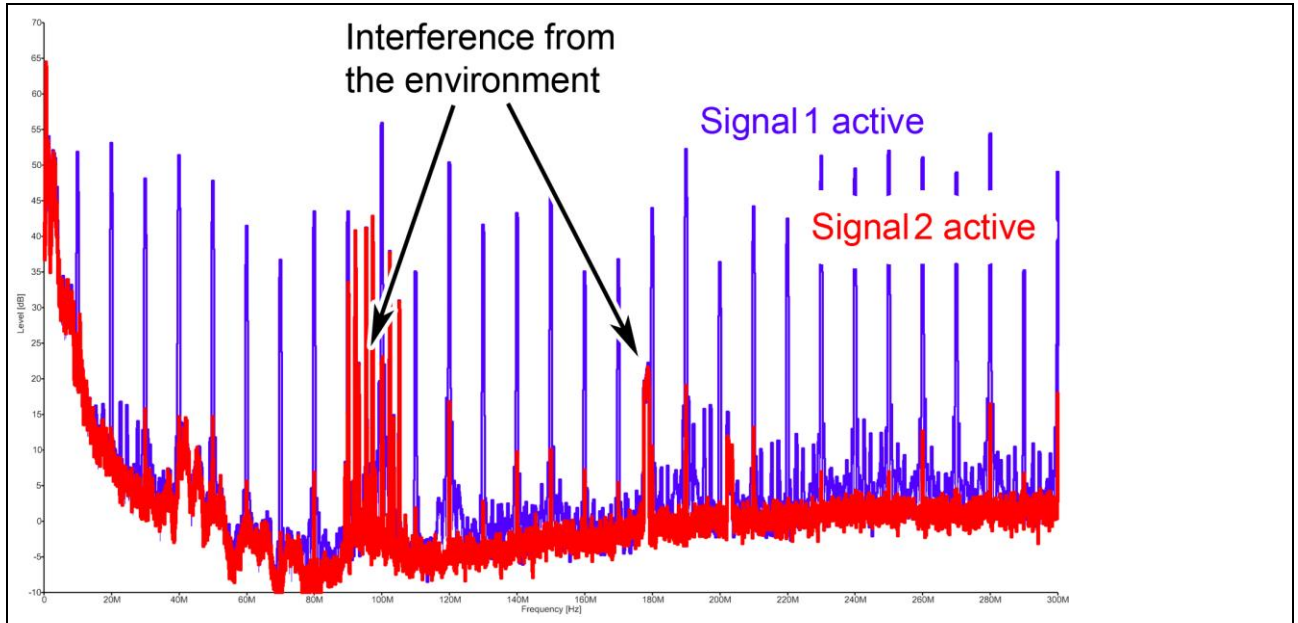

Figure 24: Measured emission of a demo board with two cables connected

### 7.2.2 Tests with ESA1 Emission Development System

For comparative measurements with different DUTs or for the evaluation of modifications to DUTs during development, measurement procedures such as those possible with the ESA1 emission development system are suitable.

Figure 25 shows a typical set-up: The SA 11 (or SA 21 respectively) demo board is connected with its supply line to the HFW 21 RF current transformer on one side. The supply voltage coming from the power supply unit is fed through filters in the metallic GP 23 base plate and through the current transformer.

Since the interference emission of the demo board is via the connected line (typical for most electronic boards), the RF current in this line can be used as a measure for the interference emission of the demo board.

For a better overview, Figure 25 was photographed without the associated shielding tent.

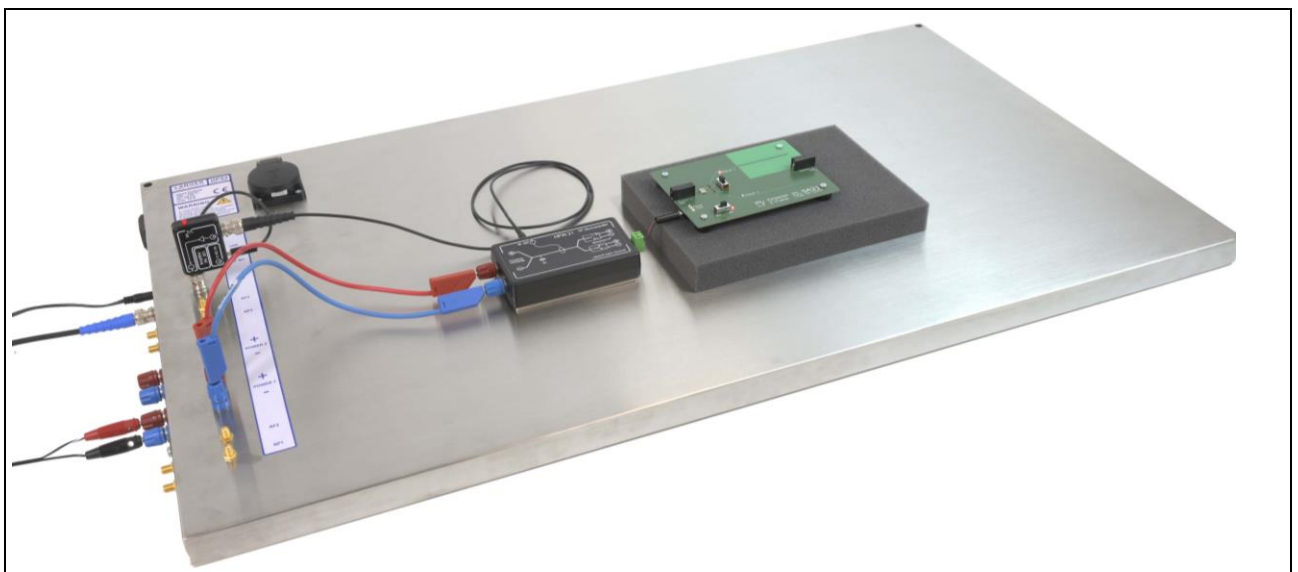

Figure 25: RF current measurement with SA 11 demo board and HFW 21 RF current transformer

It is recommended to measure and store the RF current with a spectrum analyzer to show the different effects of Signal 1 and Signal 2 or changes in the test set-up. In conjunction with a spectrum analyzer, we recommend using the ChipScan-ESA software (from Langer EMV-Technik GmbH) with which the following measurement results were also recorded.

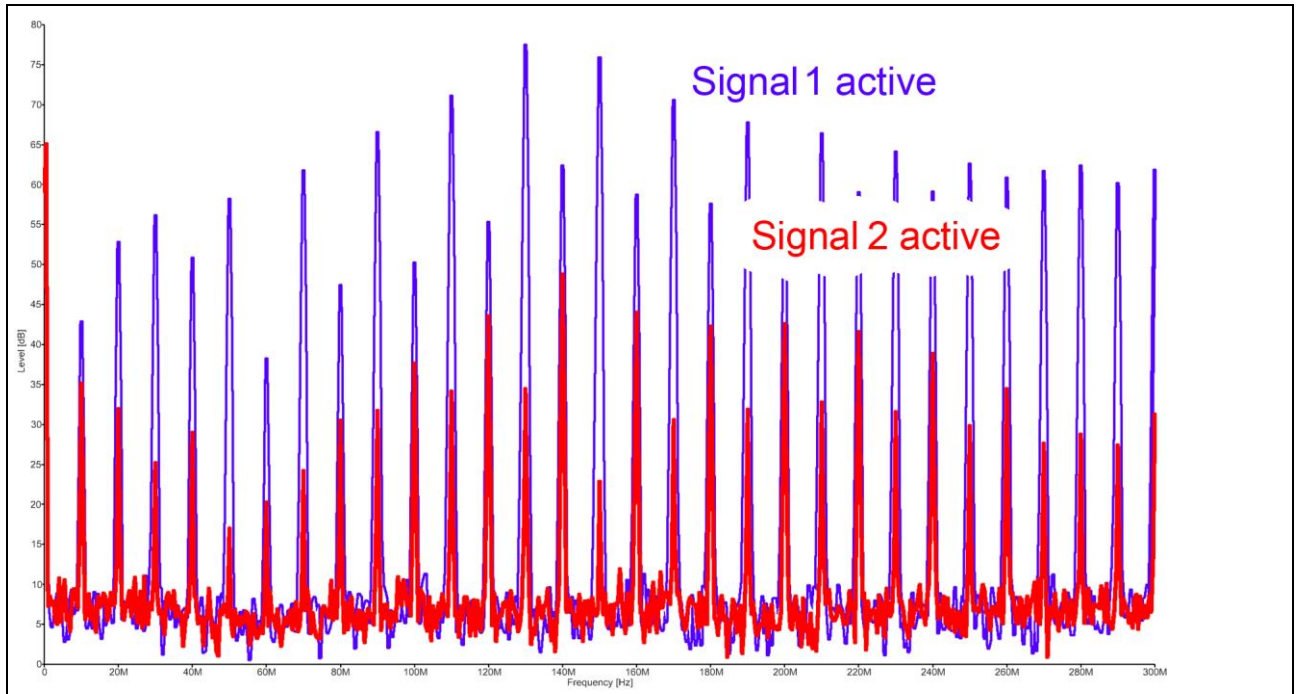

Figure 26: RF current measured at SA 11 with HFW 21

Figure 26 shows the measurement results with SA 11 single-pole connection. The oscillator frequency of SA 11 and SA 21 is 10 MHz, the harmonics are clearly visible as needles in the spectrum. For practical demonstrations, the frequency range below 300 MHz is suitable, since at higher frequencies, depending on the ambient conditions, additional effects can occur and the measurement results become less clear.

### 7.2.3 Tests with Near-Field Probes

As a simplified variant for comparative measurements or for the evaluation of modifications, the RF current on the supply line can be measured with a near-field probe as shown in Figure 27. In addition to the RF current generated by the DUT, the RF current coupled in from the environment (radio transmitter, etc.) is also measured. The length and position of the supply line also influence the measurement result.

The SA 11 demo board is particularly suitable because the decoupling of electric field is particularly effective when only one cable is connected. This cable - the power supply line - is measured with the near-field probe (Figure 27).

Depending on the DUT it may be useful to increase the sensitivity of the measurement set-up by using a ferrite collapsible core (Figure 28). The core increases the transformer coupling between the supply line and the near-field probe. Under unfavorable ambient conditions, however, interference from the environment can cause the spectrum analyzer input to be overloaded, so that this test set-up is not generally recommended.



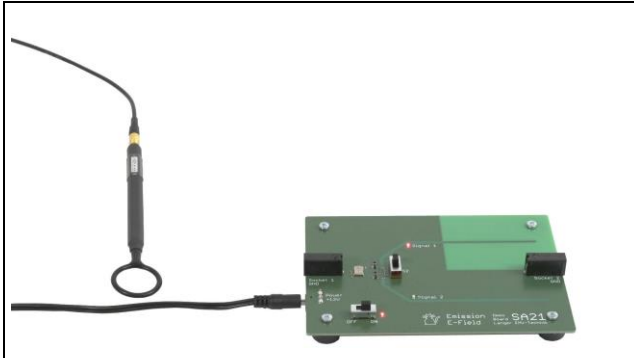

Figure 27: RF current measurement on the supply line connected to the SA 11 demo board



Figure 28: Using a ferrite core for the RF current measurement

In addition to comparative measurements on cables, small near-field probes can be used to search for and analyze RF sources on circuit boards. The SA 11 and SA 21 demo boards are suitable for almost all types of near-field probes. Figure 29 shows an example of the handling of an RF-R 50-1 magnetic near-field probe. If Signal 1 is active, the gap in the GND system can be quickly determined as the most important source of magnetic field. If Signal 2 is active, the magnetic field is significantly reduced.

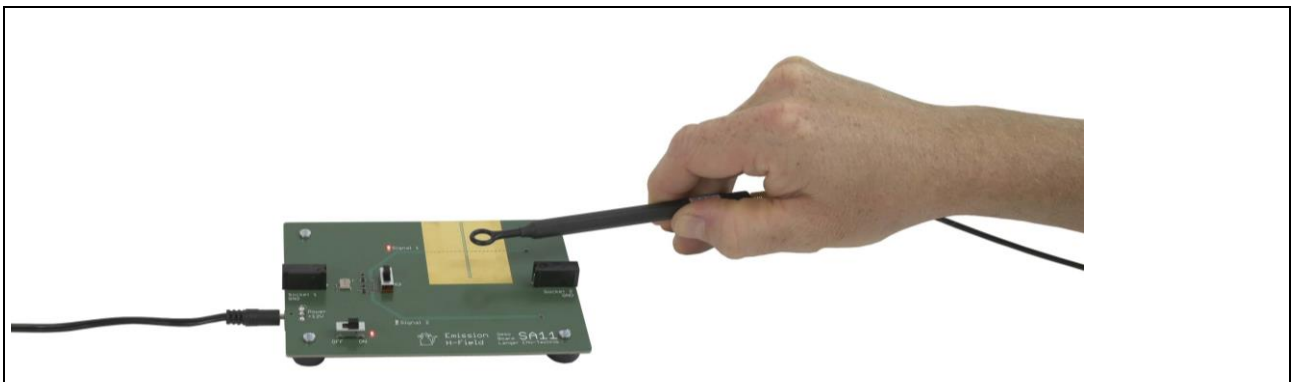

Figure 29: Magnetic field measurement on the SA 21 with RF-R 50-1 near-field probe

For comparison, Figure 30 and Figure 31 show the magnetic fields emerging vertically from the assemblies at 60 MHz. The measurements were performed with the RF-B 3-2 magnetic field probe and a Langer Scanner.

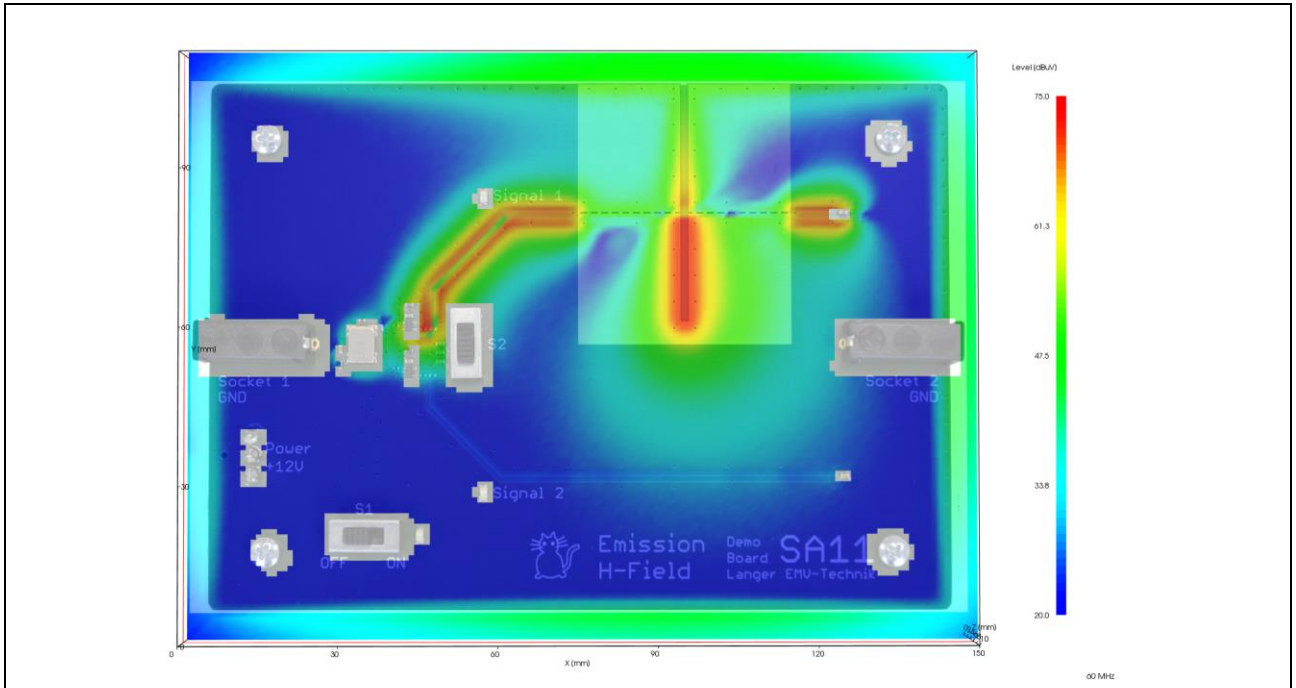

Figure 30: Vertical component of the magnetic field at 60 MHz; SA 11; Signal 1 active

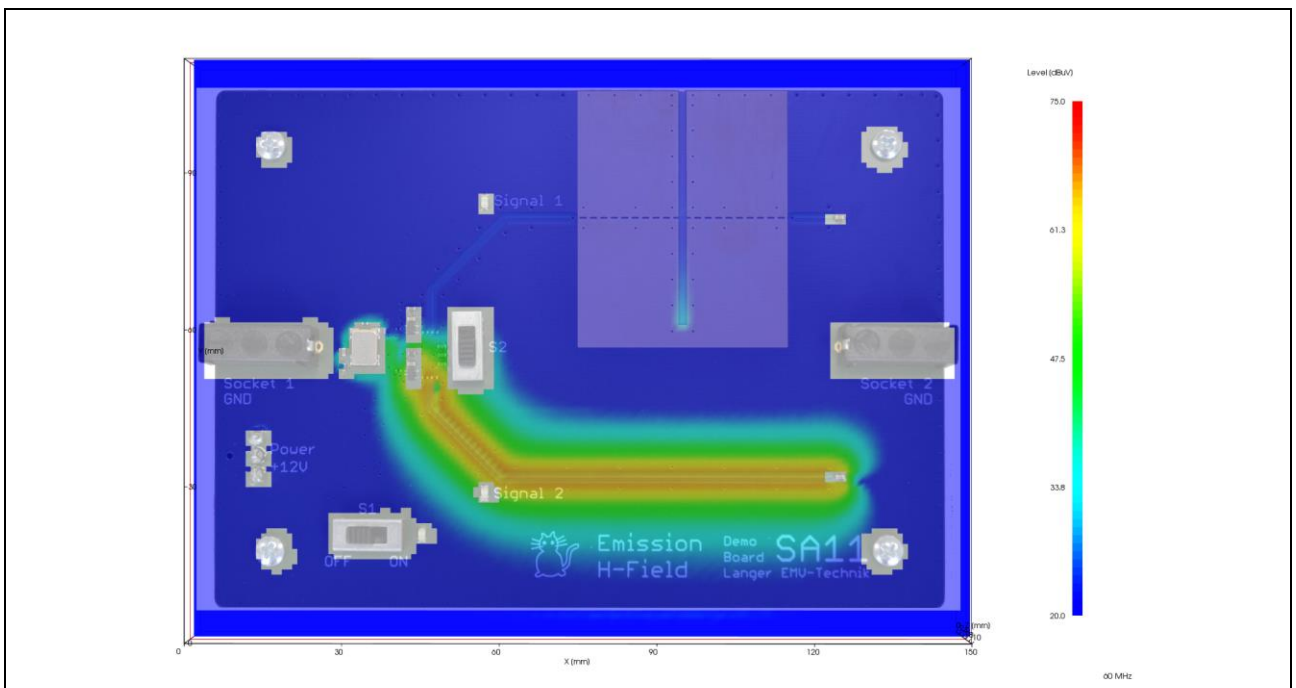

Figure 31: Vertical component of the magnetic field at 60 MHz; SA 11; Signal 2 active

If Signal 2 is active, almost no magnetic field can be detected outside the GND area of the demo board. This result corresponds to the measurements with antenna (see Section 7.2.1) and RF current transformer (see Section 7.2.2).

The SA 11 can be modified with copper adhesive tape or similar (Figure 32). If Signal 1 is active, magnetic field is decoupled through the gap in the GND system. By bridging the gap, the field can be reduced so that an interference emission as in the case of "Signal 2 active" is achieved.

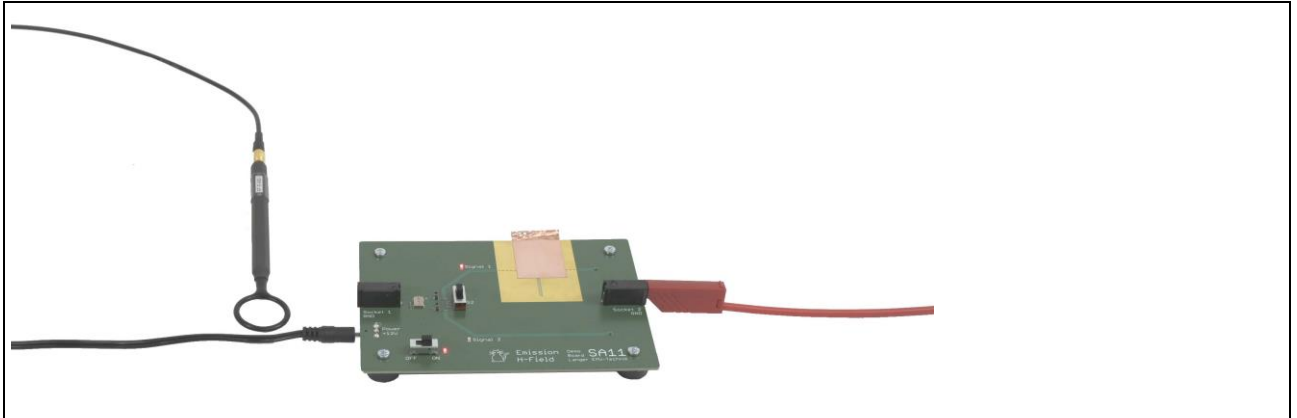

Figure 32: Modification of SA 21 demo board: gap bridged with copper tape

**Hint:**

If the copper adhesive tape is bonded to the assembly, the contact resistance due to the adhesive layer is often too high. Not enough eddy current can flow, thus the effect is limited. It is recommended to place the copper adhesive tape with the copper side down on the demo board and press it on. This way the contact resistance is very low and the eddy current is correspondingly high. The protective effect is at maximum.

## 8 Customer Support

Please contact us if you have any queries, hints and suggestions.

You can reach us: Monday - Friday 8:00 am to 3:00 pm (CET)

Contact us at: Langer EMV-Technik GmbH  
Rosentitzer Straße 73  
01728 Bannewitz  
Germany

Internet: <https://www.langer-emv.com>

E-mail: [mail@langer-emv.de](mailto:mail@langer-emv.de)

Phone: +49 (0) 351-430093-0  
Fax: +49 (0) 351-430093-22

## 9 Warranty

Langer EMV-Technik GmbH will remedy any fault due to defective material or defective manufacture during the statutory warranty period either by repair or by delivery of spare parts.

**This warranty is only granted on condition that:**

- The information and instructions in the user manual have been observed.

**The warranty will be forfeited if:**

- An unauthorized repair is performed on the product.
- The product is modified.
- The product is not used for its intended purpose.
- The product is opened.

This document may not be copied, reproduced or electronically processed, either in its entirety or in part, without the prior written permission of Langer EMV-Technik GmbH. The management of Langer EMV-Technik GmbH assumes no liability for damage that may arise from using this printed information.

LANGER  
EMV-Technik-GmbH

Noethnitzer Hang 31  
DE-01728 Bannewitz  
www.langer-emv.com

Tel.: +49 (0) 351/430093-0  
Fax: +49 (0) 351/430093-22  
mail@langer-emv.de